

413nm 300mW 14-Pin Butterfly Package Fiber Coupled Diode Laser With TEC | Violet Laser Diode
410nm~413nm| 14-Pin BTF Package With 105um UV Fiber |Built-in TEC Cooling | Built-in PD
WSLX-413-300m-M-H14-T-PD
Wavespectrum Laser Group
www.wavespectrum-laser.com

PARAMETER	SYMBOL	VALUE	UNIT
Reverse Voltage	V_r	2.0	V
Operating Temperature	T_{op}	0 ~ +30	°C
Storage Temperature	T_{stg}	-40 ~ +85	°C
Lead soldering temperature (10 sec.)	T_{is}	260	°C

Features:

- 413nm
- 300mW Output Power
- Built-in TEC Cooling
- Built-in Photodiode
- High Stability

Applications:

- Medical Laser Treatment
- Others

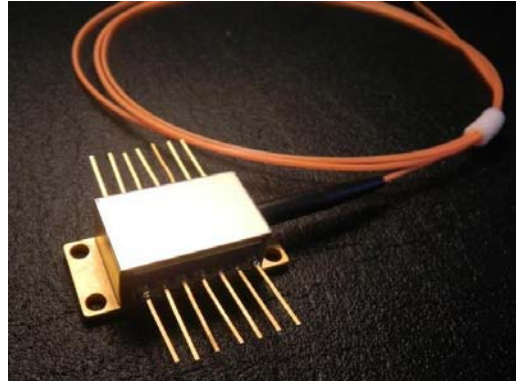
Specifications
WSLX-413-300m-M-H14-T-PD

	Min.	Type	Max.
Center Wavelength@25°C	413nm±10nm		
Spectral Width (FWHM)	----	2nm	----
Output Power	----	300mW	----
Recommended Operating Temperature	25 °C		
Threshold Current (Typ.)	----	140mA	200mA
Operating Current (Typ.)	----	360mA	380mA
Operating Voltage		4.5V	5.5V
TEC Max Current	2A		
TEC Max Voltage	8V		
Fiber Type	UV Multi-mode Fiber		
Fiber Core	105um		
Fiber Length	>80cm		
Connector Type	SMA905/FC		
Package	14-Pin		

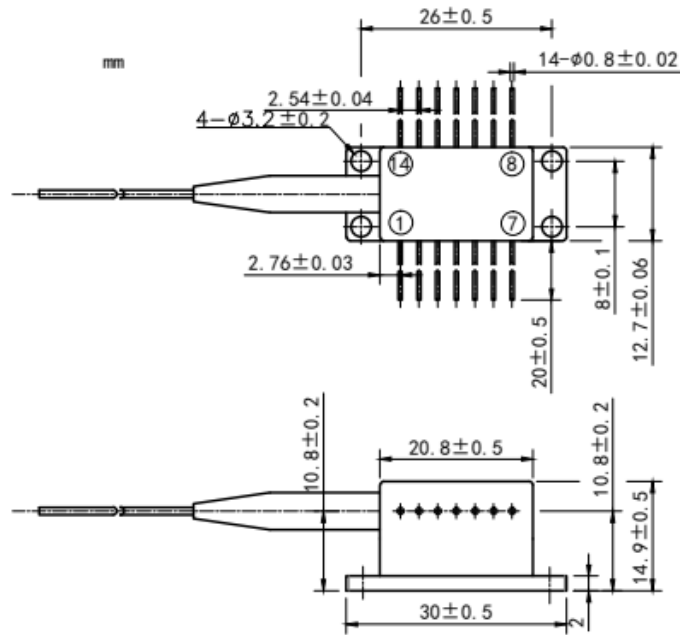

14-Pin Package View:

Pin Out:

PIN	FUNCTION	PIN	FUNCTION
1	TEC(+)	14	TEC(-)
2	THERMISTOR	13	CASE
3	PD(+)	12	NC
4	PD(-)	11	LD(-)
5	THERMISTOR	10	LD(+)
6	NC	9	NC
7	NC	8	NC

Electrically shorten LD module and store in non-extreme conditions.

Suggest using the constant current power supply.

