

670nm 1W TO Can Laser Diode | High Power Red LD with TO3 Package

660nm~670nm 1W Laser Diode | TO3 Package LD | FAC Optional

WSLD-670-001-3

Wavespectrum Laser Group

www.wavespectrum-laser.com

en.wavespectrum-laser.com.cn

670nm Laser Diode 1W/TO3

PARAMETER	SYMBOL	VALUE	UNIT
Reverse Voltage	V_r	2.0	V
Operating Temperature	T_{op}	+10~+30	°C
Storage Temperature	T_{stg}	-20~+80	°C
Lead soldering temperature (10 sec.)	T_{is}	260	°C

Features:

- 670nm
- High Power ,CW, Multi-mode
- High Quality
- TO3 Package

Applications:

- Medical Laser treatment
- Laser Indicator
- Laser Detector



Specifications

WSLD-670-001-3

	Min	Type	Max
Center Wavelength@25°C	670nm ± 10nm		
Spectral Width (FWHM)		2nm	
Output Power		1W	
Emitter Area		100x1μm	
Beam Divergence (FWHM)		35° _⊥ x 8° _{//}	
Temperature Coefficient of Wavelength		0.2nm / °C	
Slope Efficiency		1.1W/A	
Threshold Current (Typ.)		0.4A	
Operating Current (Typ.)		1.5A	
Operating Voltage		2.4V	
Package Style	TO3		



T03 Package View

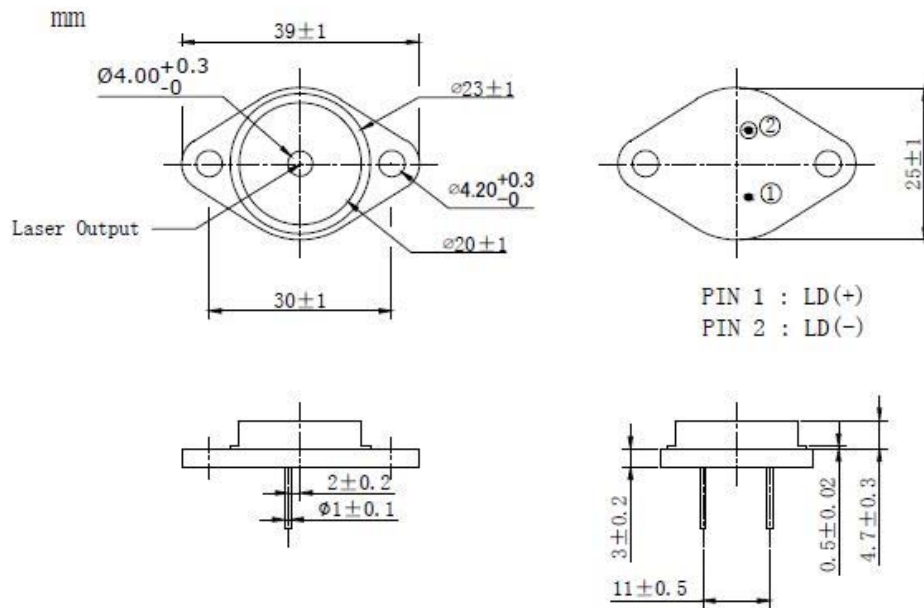

**Electrically shorten LD module and store in non-extreme conditions.
 Suggest using the constant current power supply.**



Wavespectrum Laser Group
www.wavespectrum-laser.com
sales@wavespectrum-laser.com

