

850nm 100mw SM Fiber Coupled LD with Polarization Maintaining Fiber

850nm | 80mw~100mw Output Power| PM Fiber Pigtailed Laser Diode |PMF | Built-in PD

WSLP-850-100m-PM-PD

Wavespectrum Laser Group

www.wavespectrum-laser.com

850nm Pigtailed Diode Laser		100m W/PM Fiber		Wavespectrum Laser Group	
PARAMETER	SYMBOL	VALUE		UNIT	
Reverse Voltage	V_r	2.0		V	
Operating Temperature	T_{op}	-20 ~ +50		°C	
Storage Temperature	T_{stg}	-40 ~ +80		°C	
Lead soldering temperature (10 sec.)	T_{is}	260		°C	
Features: <ul style="list-style-type: none"> • 850nm • PM Fiber • Coaxial Package • Built-in PD 					
Applications: <ul style="list-style-type: none"> • Medical laser treatment • Others 					
Specifications	WSLP-850-100m-PM-PD				
	Min	Type	Max		
Center Wavelength@25°C	840nm	850nm	860nm		
Recommend Operating Temperature	25°C				
Output Power	----	80mw	100mw		
Fiber Type	Polarization Maintaining Fiber				
Fiber Core	5um				
Monitor Current	----	0.5mA	0.8mA		
PD Reverse Voltage	----	30V	----		
Fiber Connector	FC				
Fiber Length	----	80cm	100cm		
Threshold Current (Typ.)	----	20mA	40mA		
Operating Current (Typ.)	----	190mA	220mA		
Operating Voltage	----	1.9V	2.2V		
Package Style	Coaxial				
PD	Built-in				



Coaxial Package View

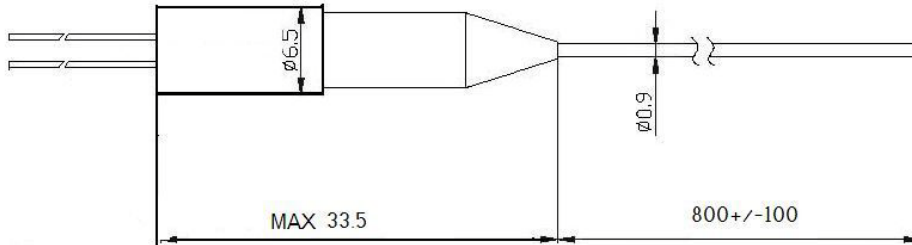

PIN Bottom View:

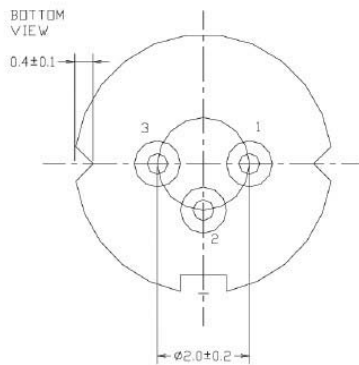

1	LD(-)
2	LD(+)&PD(-)
3	PD(+)

OR

1	LD(+)
2	LD(-)&PD(+)
3	PD(-)

Electrically shorten LD module and store in non-extreme conditions.
Suggest using the constant current power supply.

